

GEO VIRGINIA
2015

Williamsburg VA
April 27 - April 29

Lessons Learned in Geotechnical Engineering

Recent Confined Access Micropile and Shoring Projects

John Wolosick, PE, D.GE
Hayward Baker - Alpharetta, GA

**HAYWARD
BAKER**
Geotechnical Construction



One Client:

CONFIDENTIAL

Two Sites:

- 1. Food-grade Industrial Plant**
- 2. “Museum”**

Five Techniques: Micropiles

Soil Nailing

Post-Tensioned Anchors

Jacked Resistance Piers

Hydraulically installed

Soldier Piles with

Wood Lagging

Food-Grade Industrial Plant Atlanta, GA

- **23 foot deep pits indoors**
- **Undermine existing columns**
- **16 foot headroom**
- **Tight Tolerances**
- **No internal bracing**
- **No interior borings available**

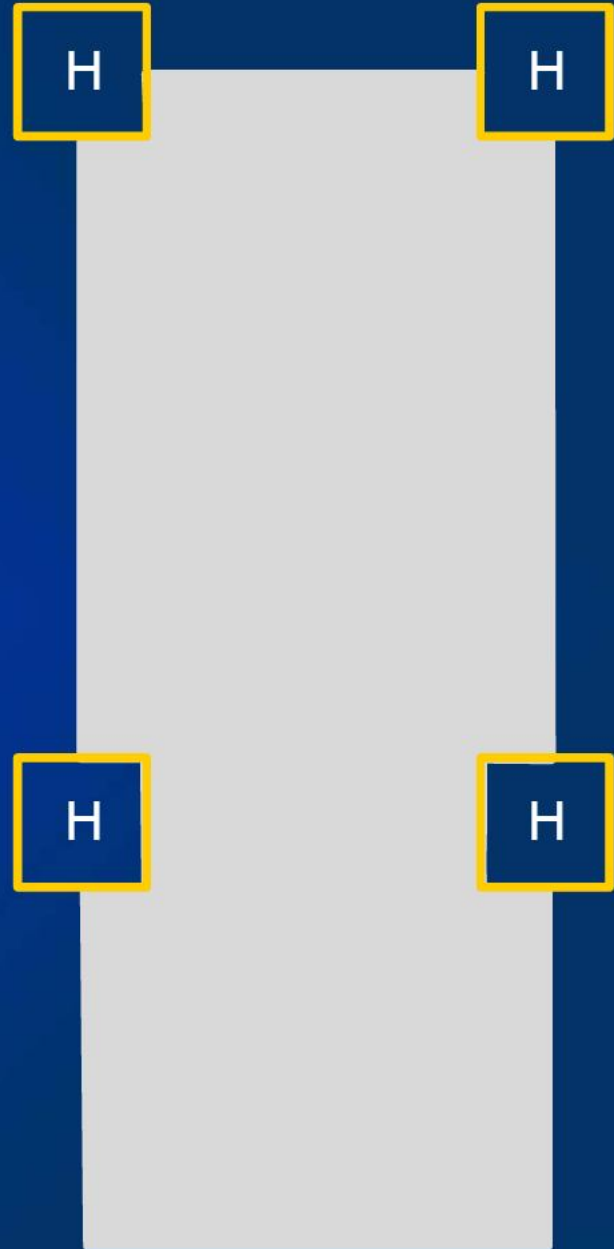

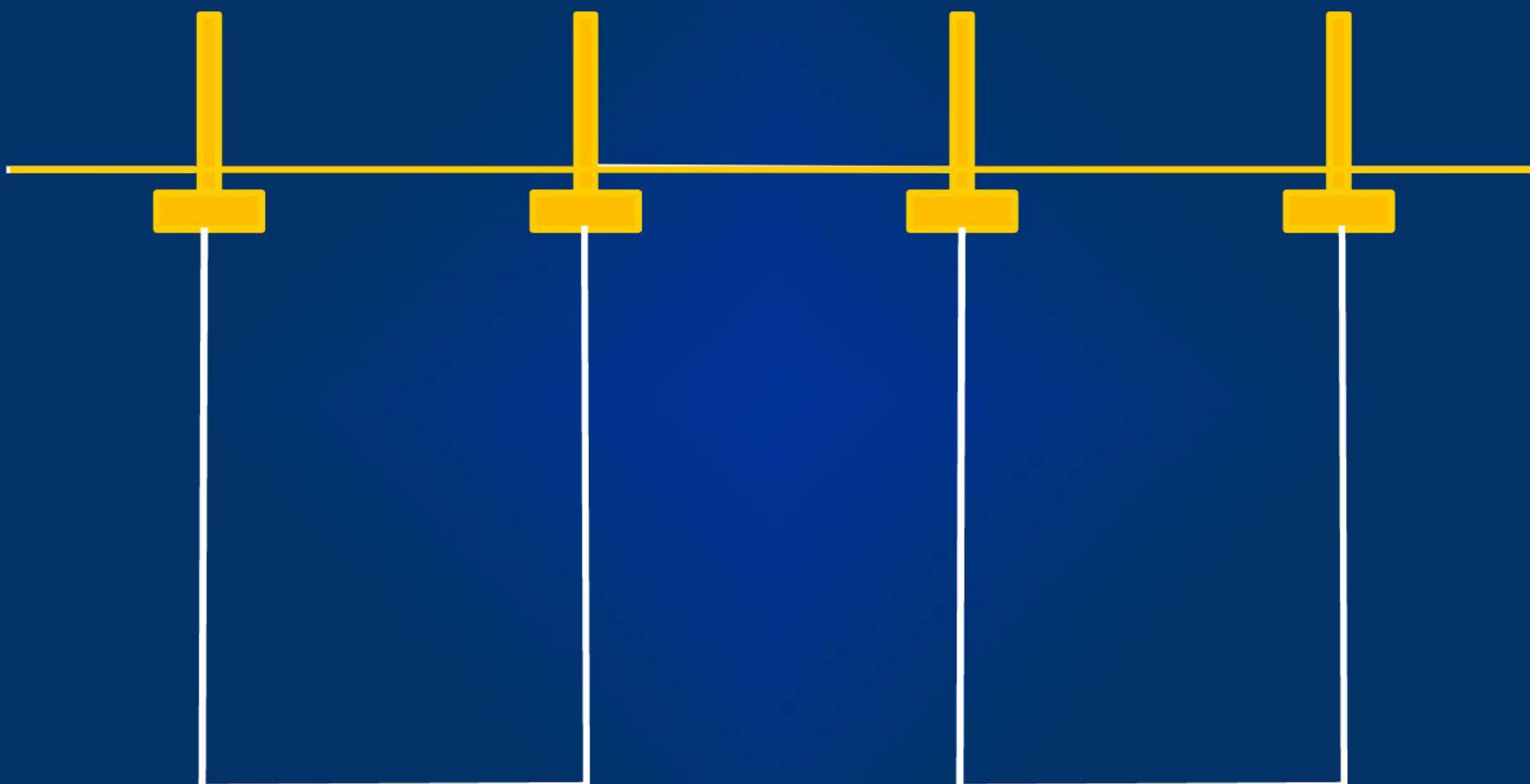

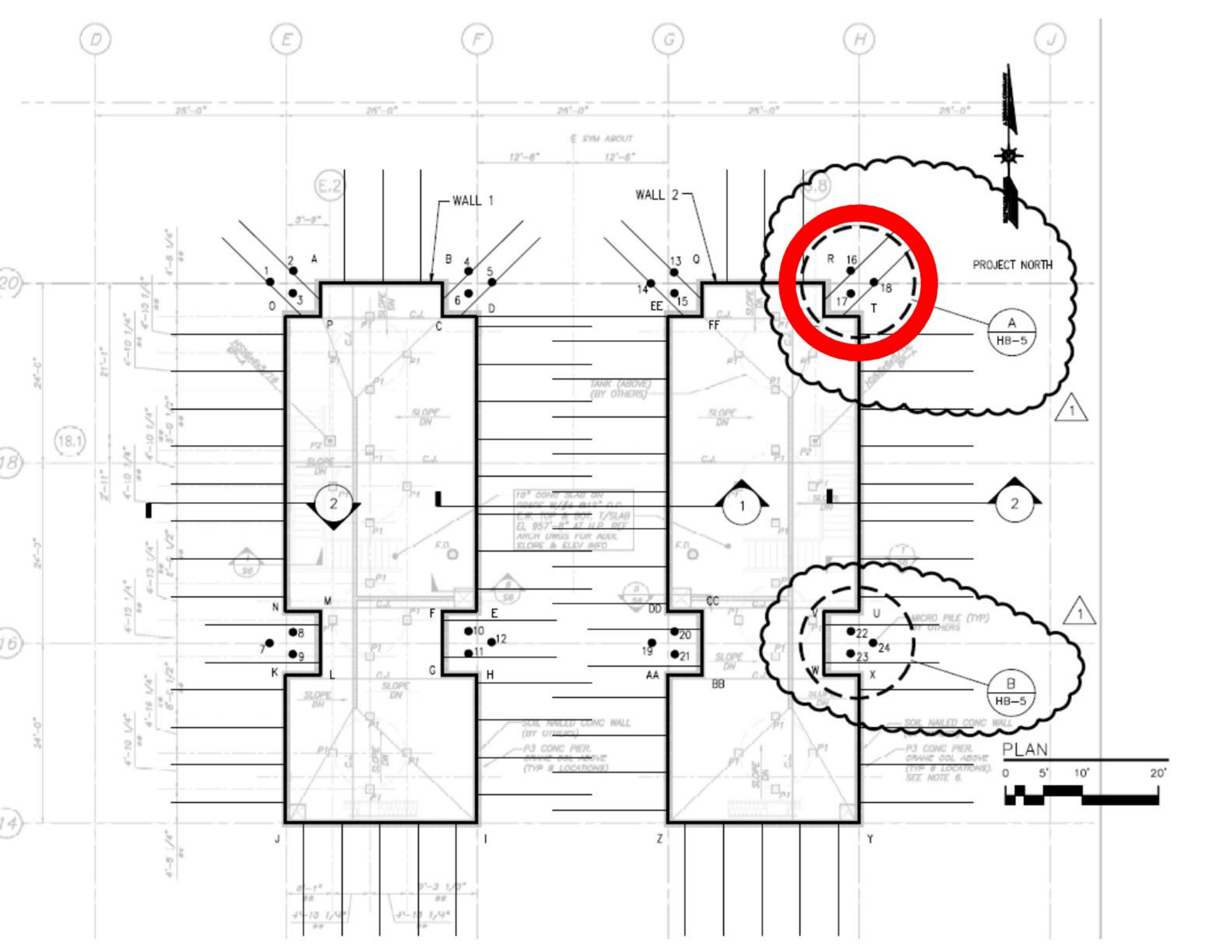

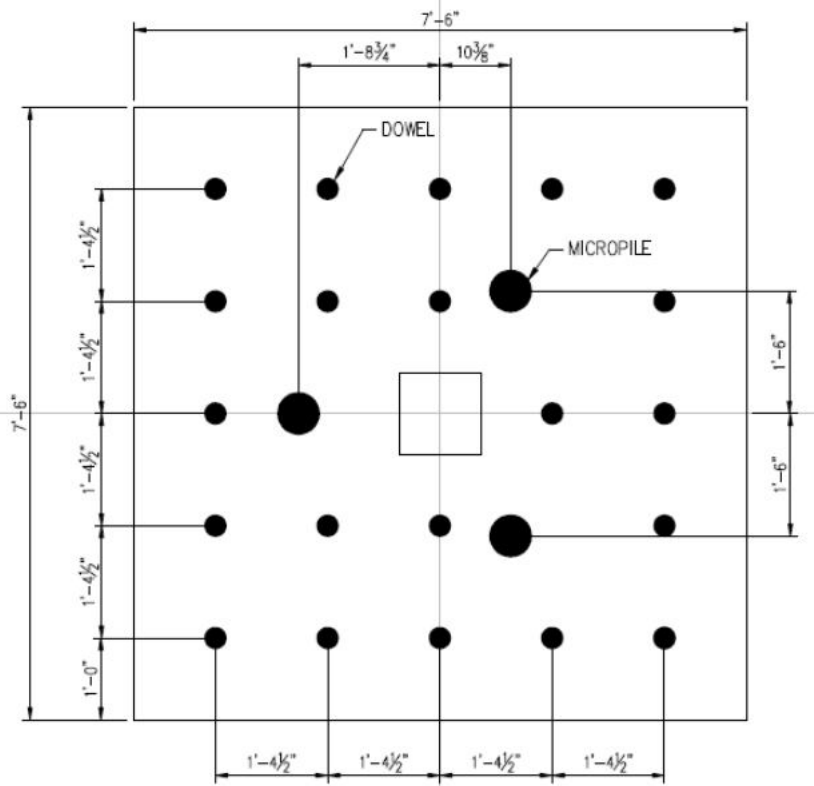

EXISTING FOOTING PLAN
NO SCALE

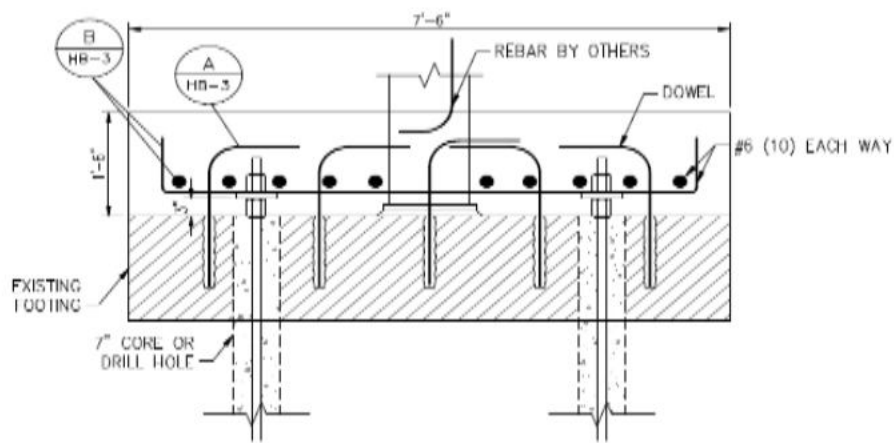

SECTION THROUGH EXISTING FOOTING
NO SCALE

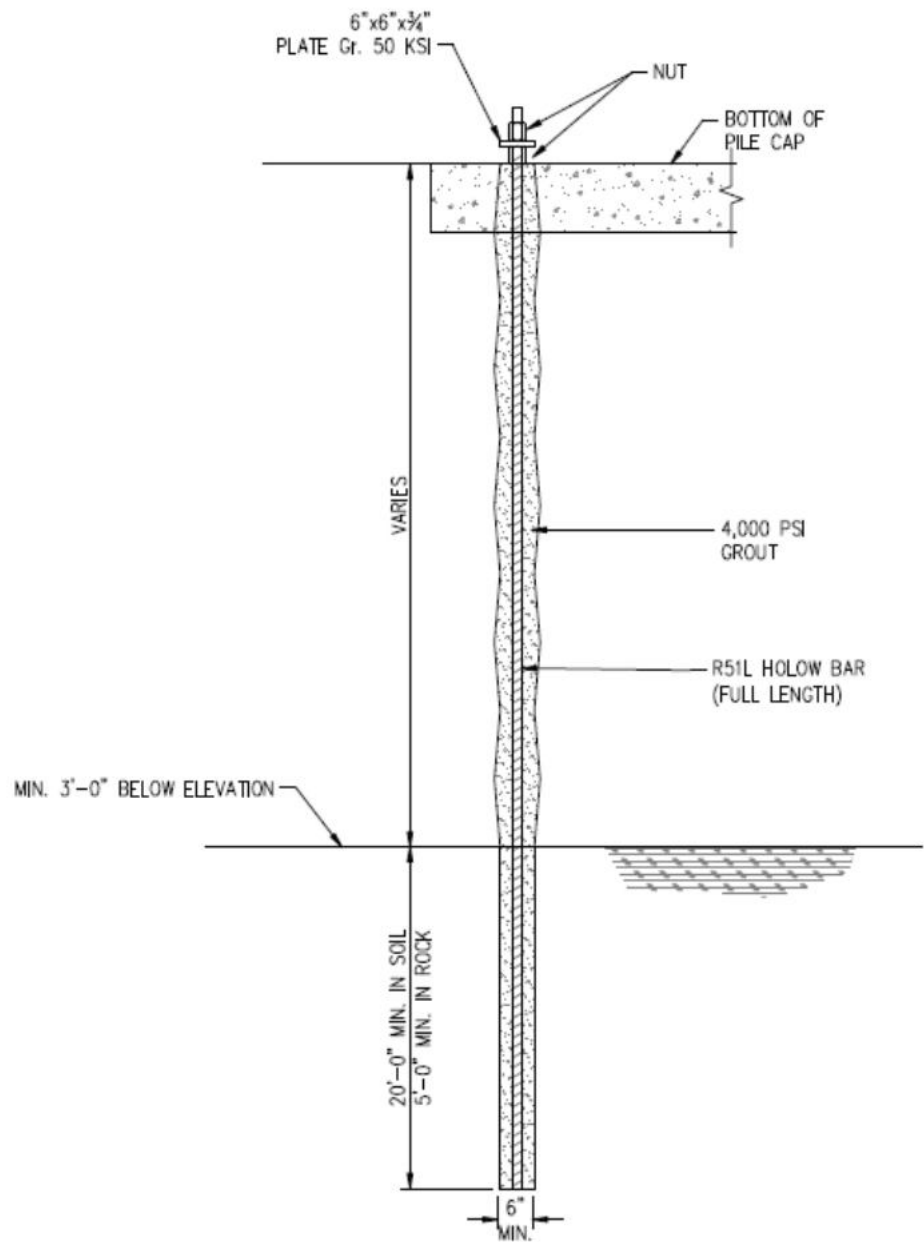

MICROPILE DETAIL
NO SCALE

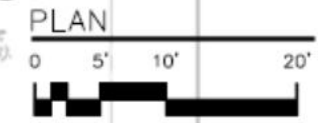
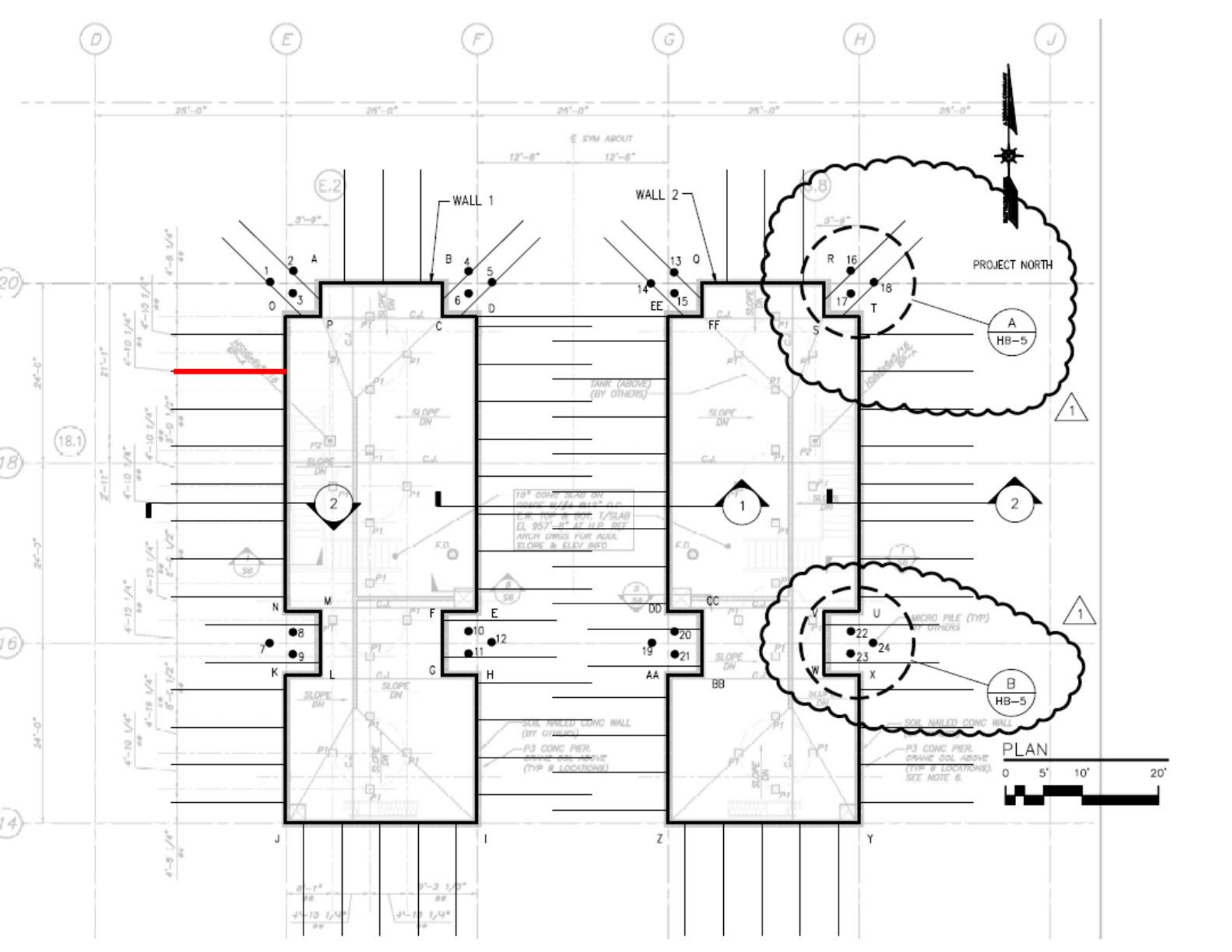

PROJECT NORTH

A
HB-5

B
HB-5

10" CONC SLAB ON
GRADE W/24" BLS* O.C.
C.W. TOP & BOT 1/2 SLAB
EL. 957'-8" AT I.D. BEF
ARCH DRWG FOR AUXL
SLOPE & ELEV MTD

SOIL NAILED CONC WALL
(BY OTHERS)
P3 CONC PER.
GRAND SOL ABOVE
(TYP & LOCATIONS)

MICRO PILE (TYP)
(BY OTHERS)

SOIL NAILED CONC WALL
P3 CONC PER.
GRAND SOL ABOVE
(TYP & LOCATIONS).
SEE NOTE 6.

E SYM ABOUT

12'-6" 12'-6"

E.2

J.8

2

1

2

1

1

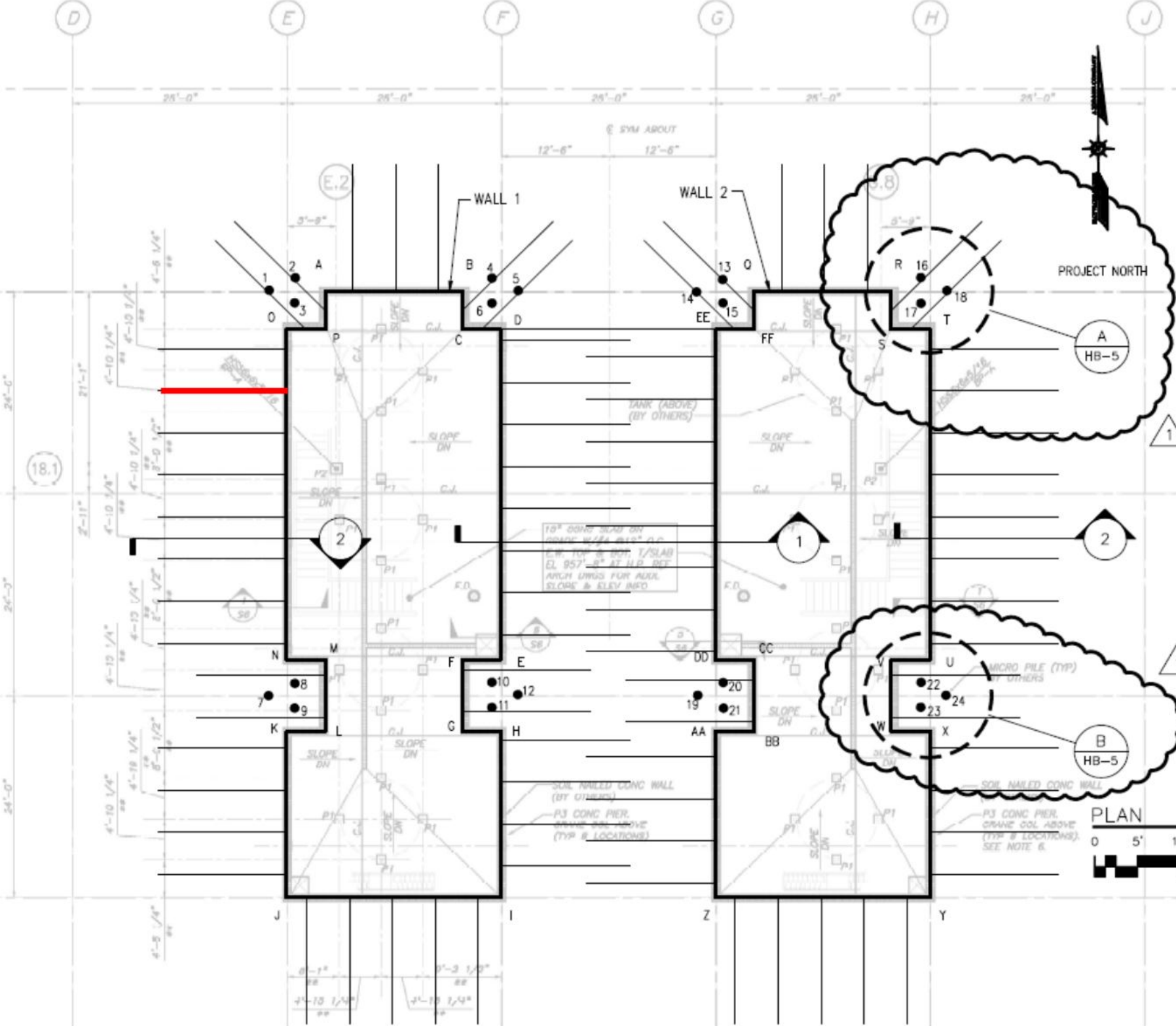

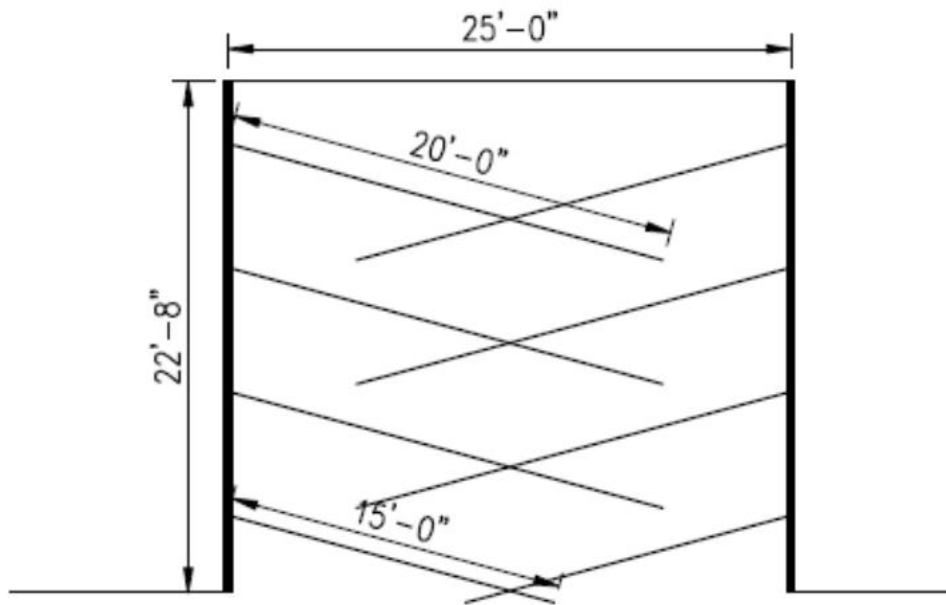

1 SECTION
NO SCALE

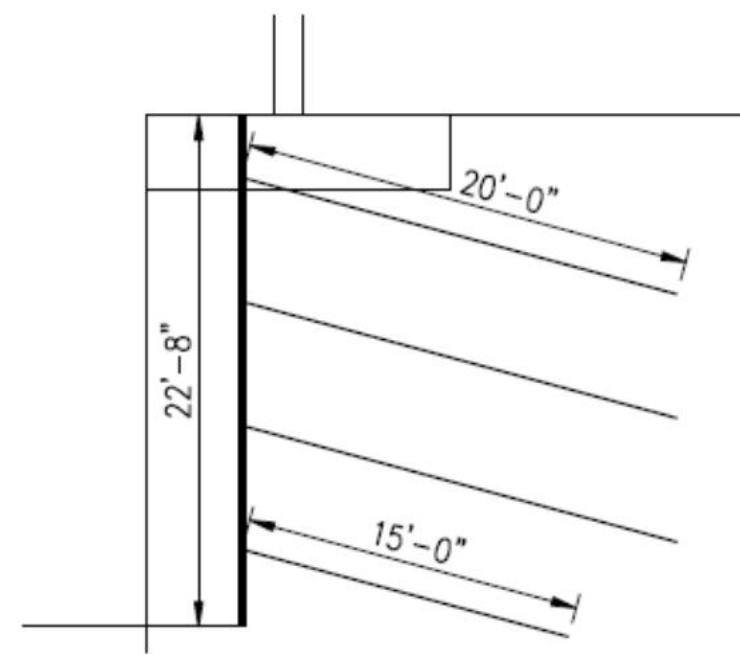

2 SECTION
NO SCALE

Soil Nailing Basic Concept

- ◆ The installation of closely spaced steel bars (“nails”) internally reinforces and strengthens the ground similar to an MSE wall as wall is constructed from top down
- ◆ The reinforcement is passive thus requiring some minor deformation to engage the nails
- ◆ Nails work in TENSION

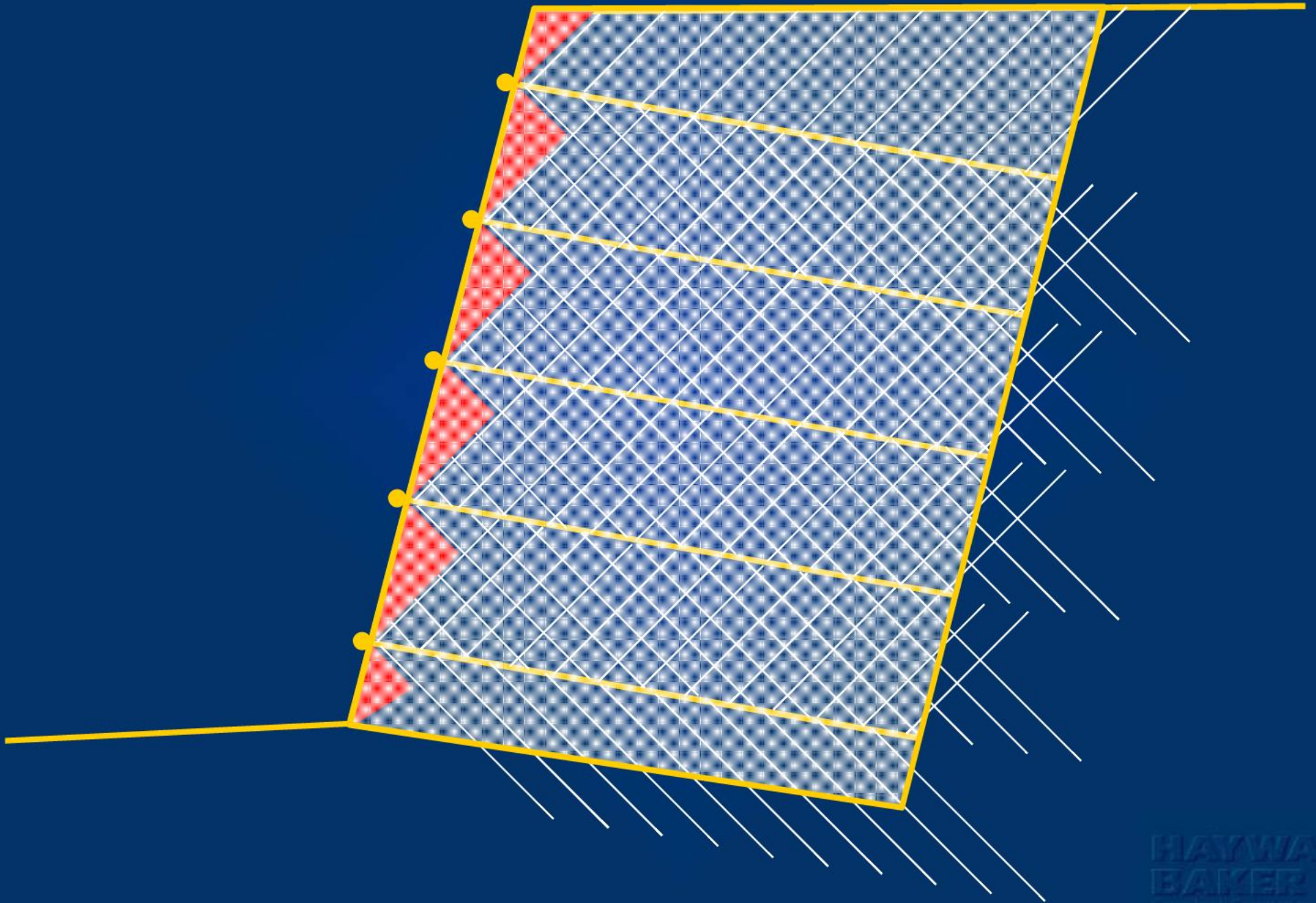

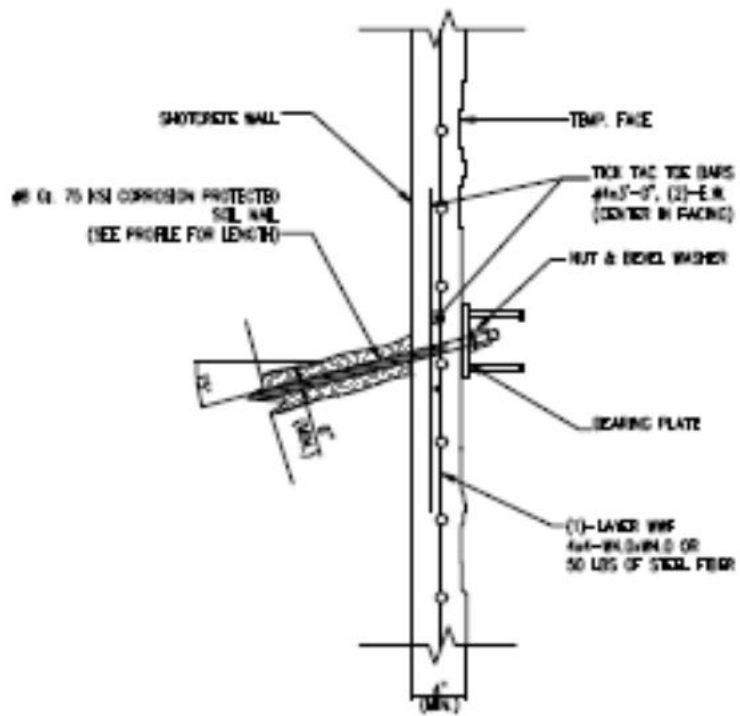

TEMPORARY SHOTCRETE FACE DETAIL
NO SCALE

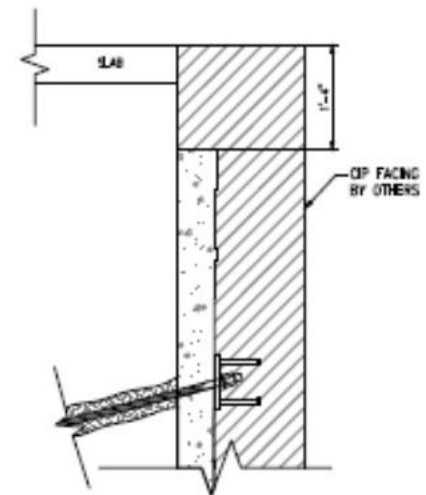

TOP OF WALL DETAIL
NO SCALE

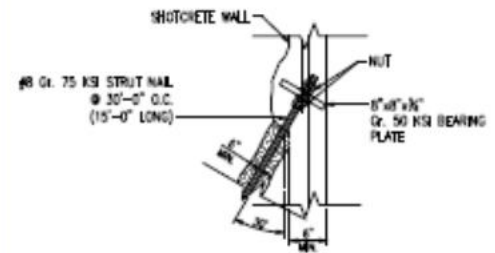

STRUT NAIL DETAIL
NO SCALE

**CAUTION
HARD HAT
AREA**







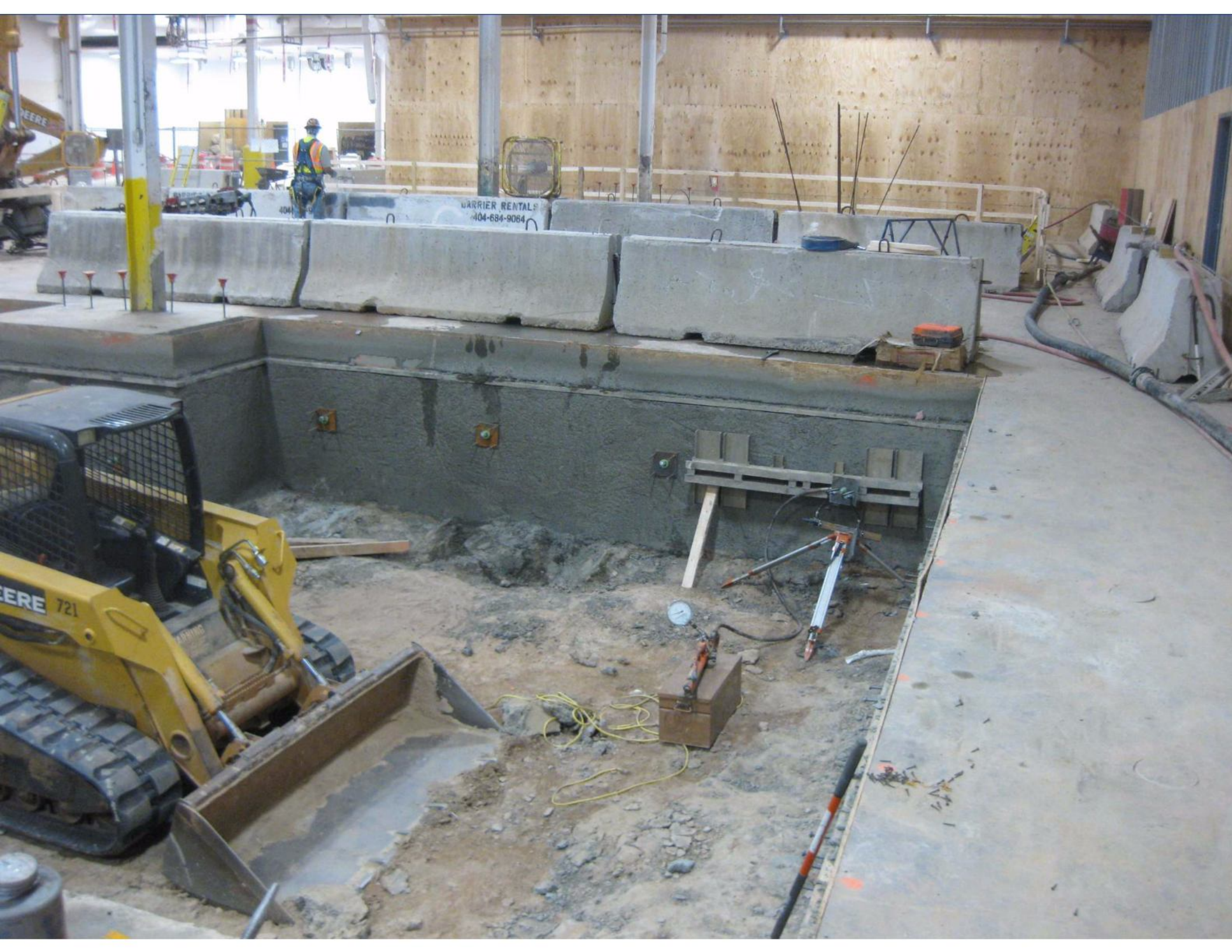





DANGER
NO ENTRY
100 YD OFF

S

185

191

190

BARRIER





200C LC

BARRETT RENTALS - BARRETT RENTALS

404-884-0964

DANGER
LEADING EDGE

BARRETT RENTALS

30



202

208
P

201

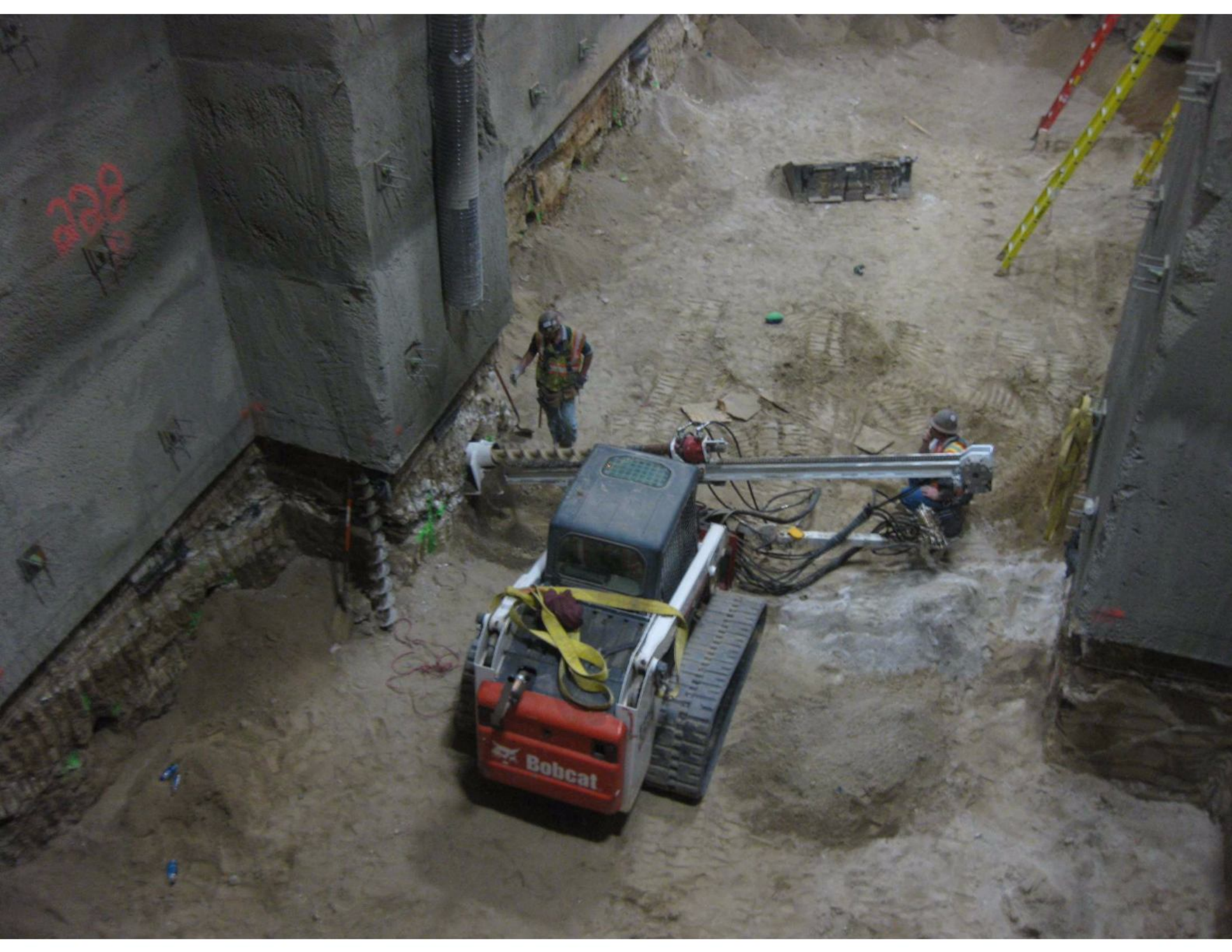





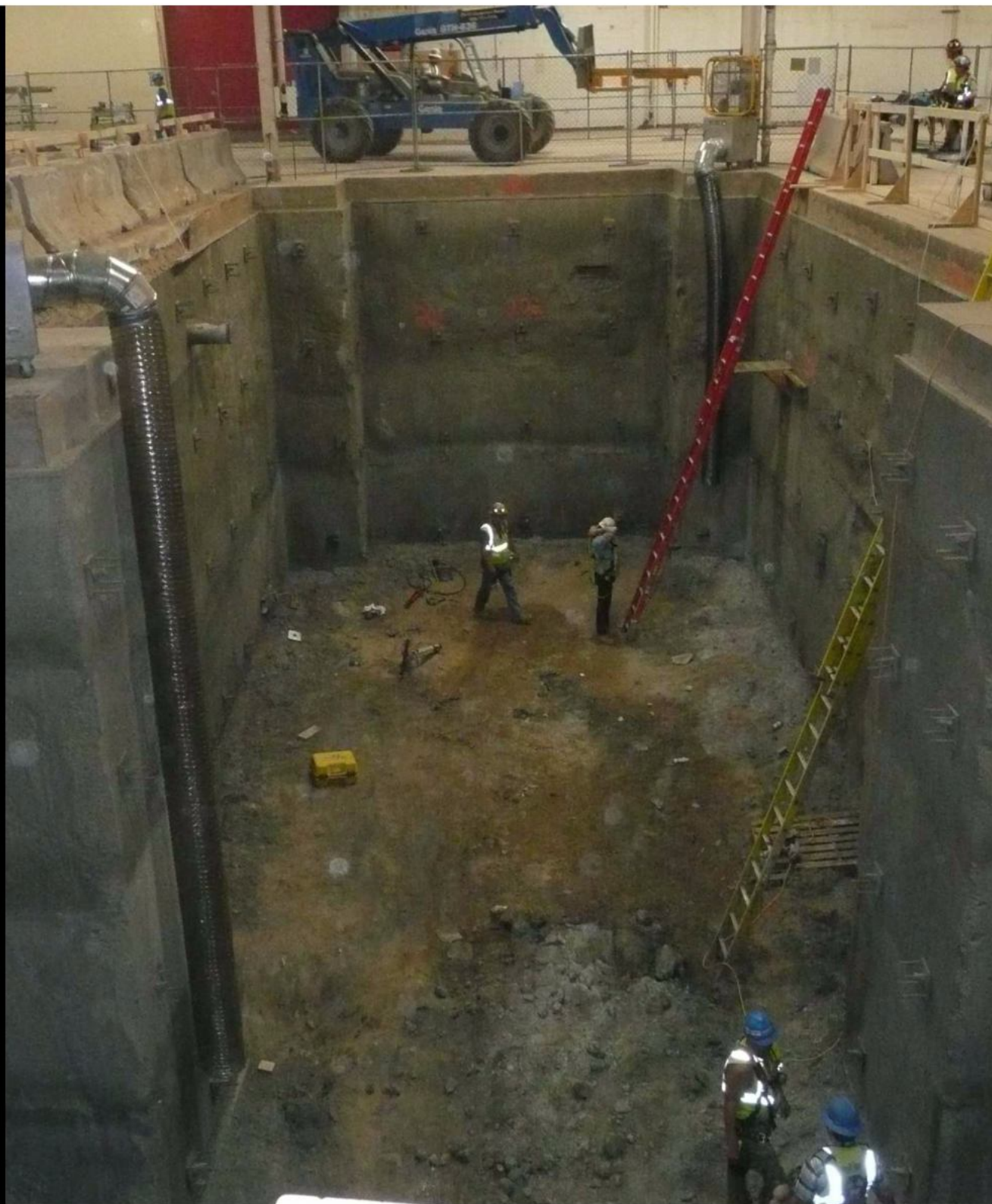

“Museum” Atlanta, Georgia

- **Planned floor elevation below existing footings**
- **Fully undermine tall glass curtain wall**
- **A lot of utilities in the vicinity**
- **Very confined site**

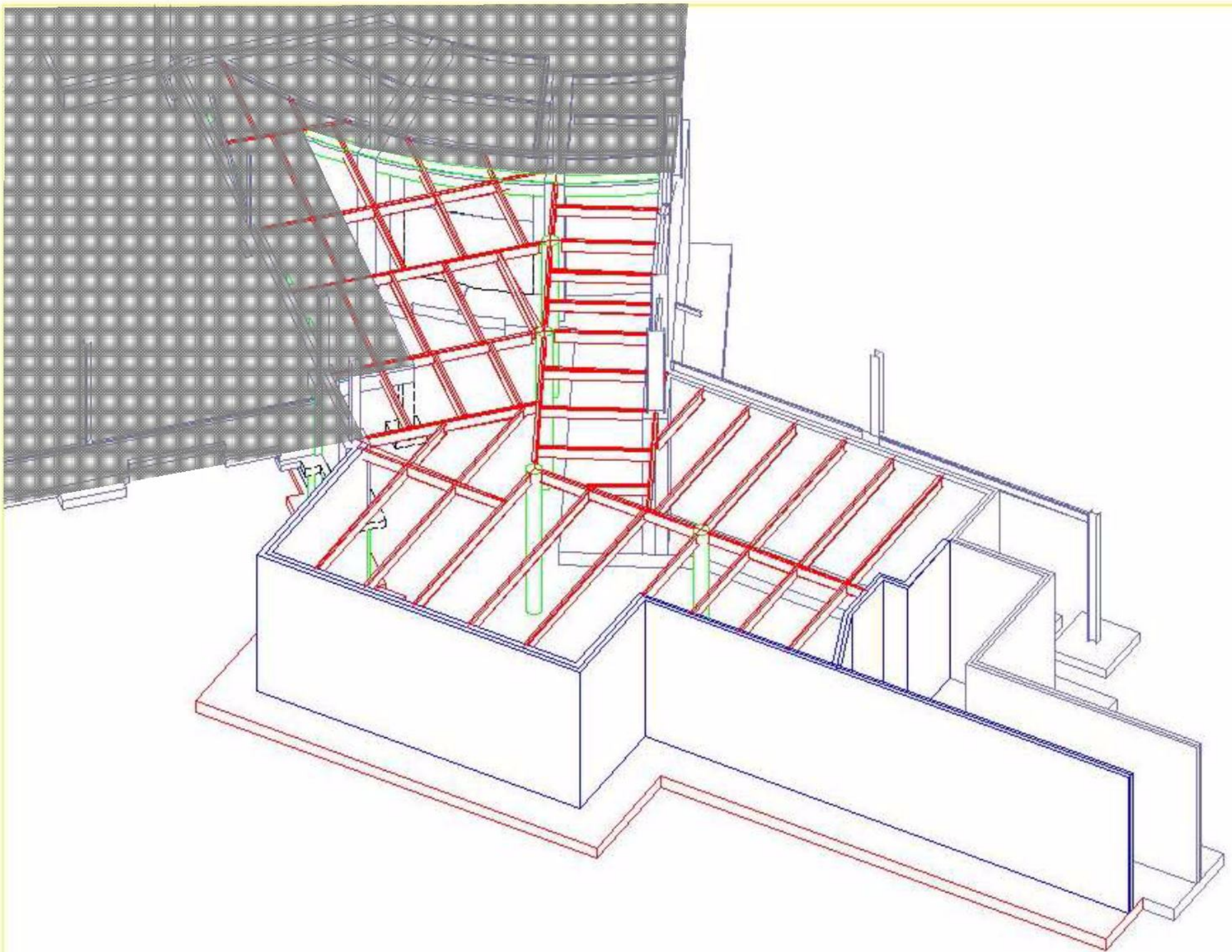

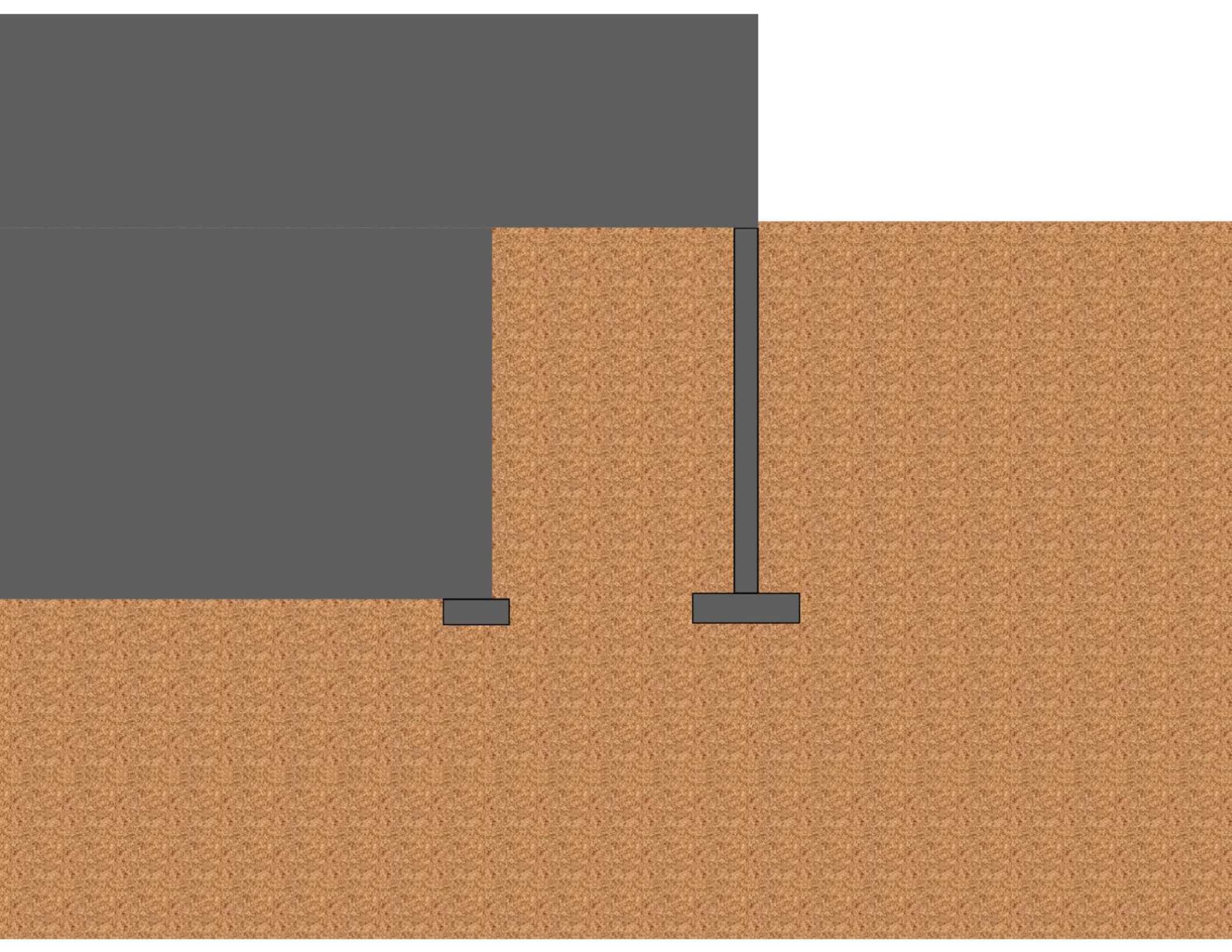

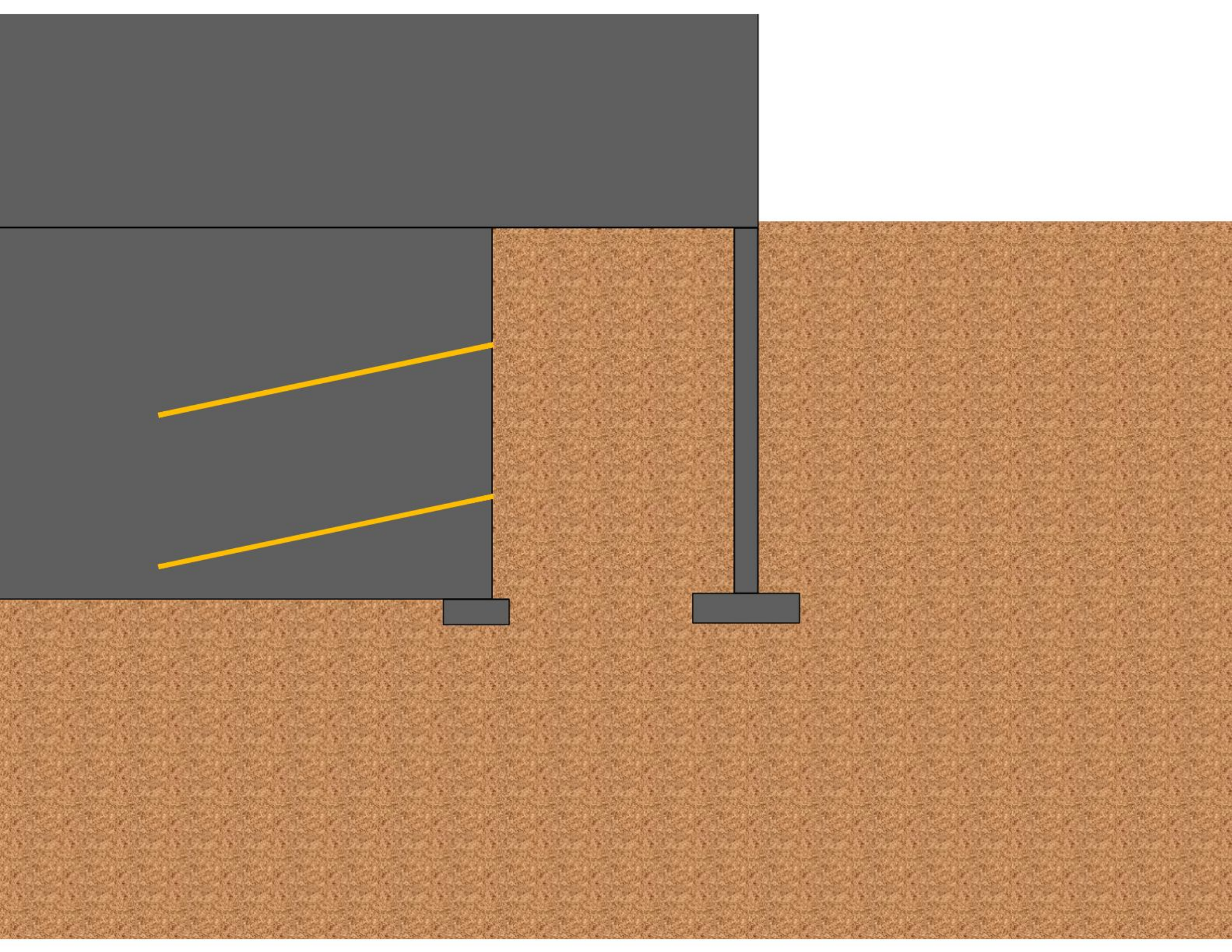



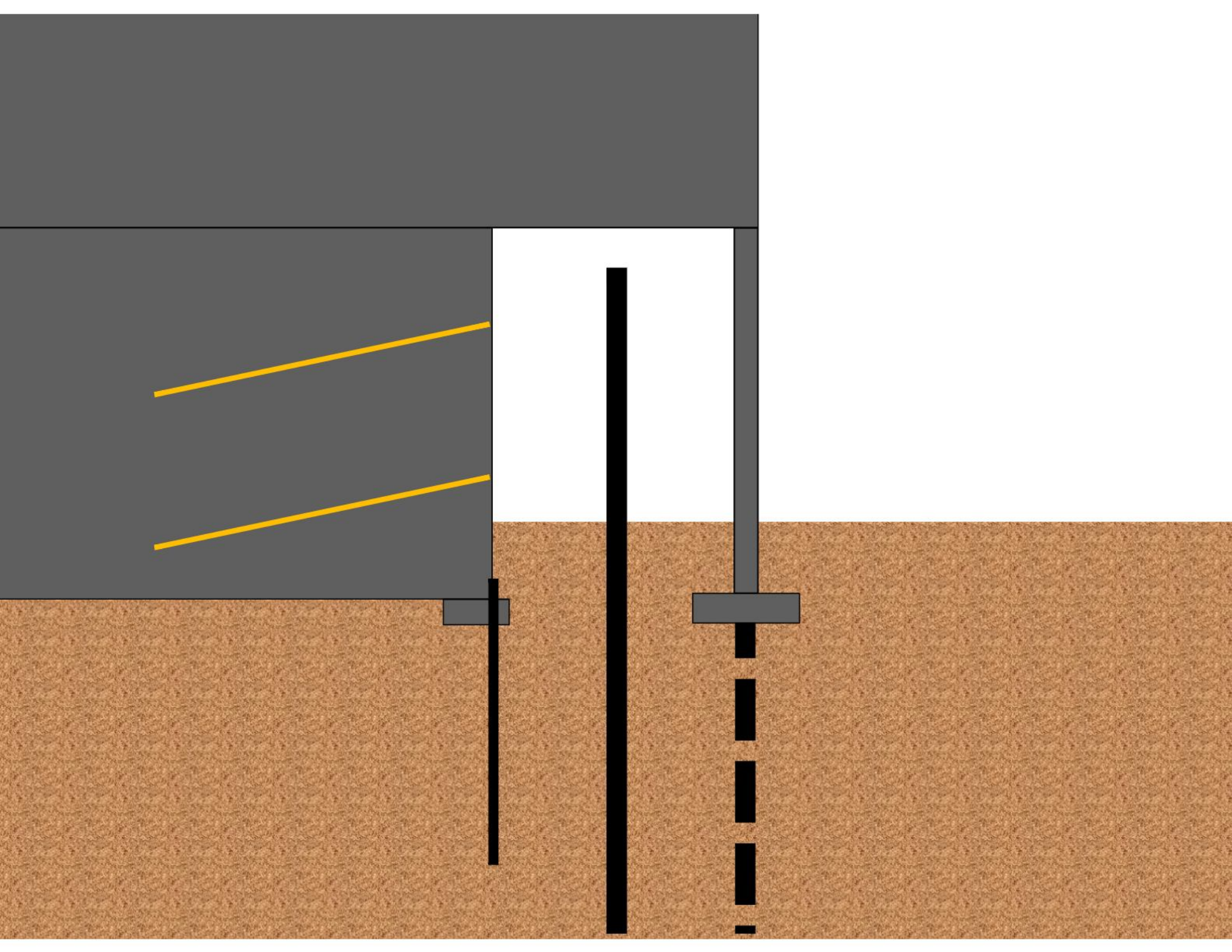

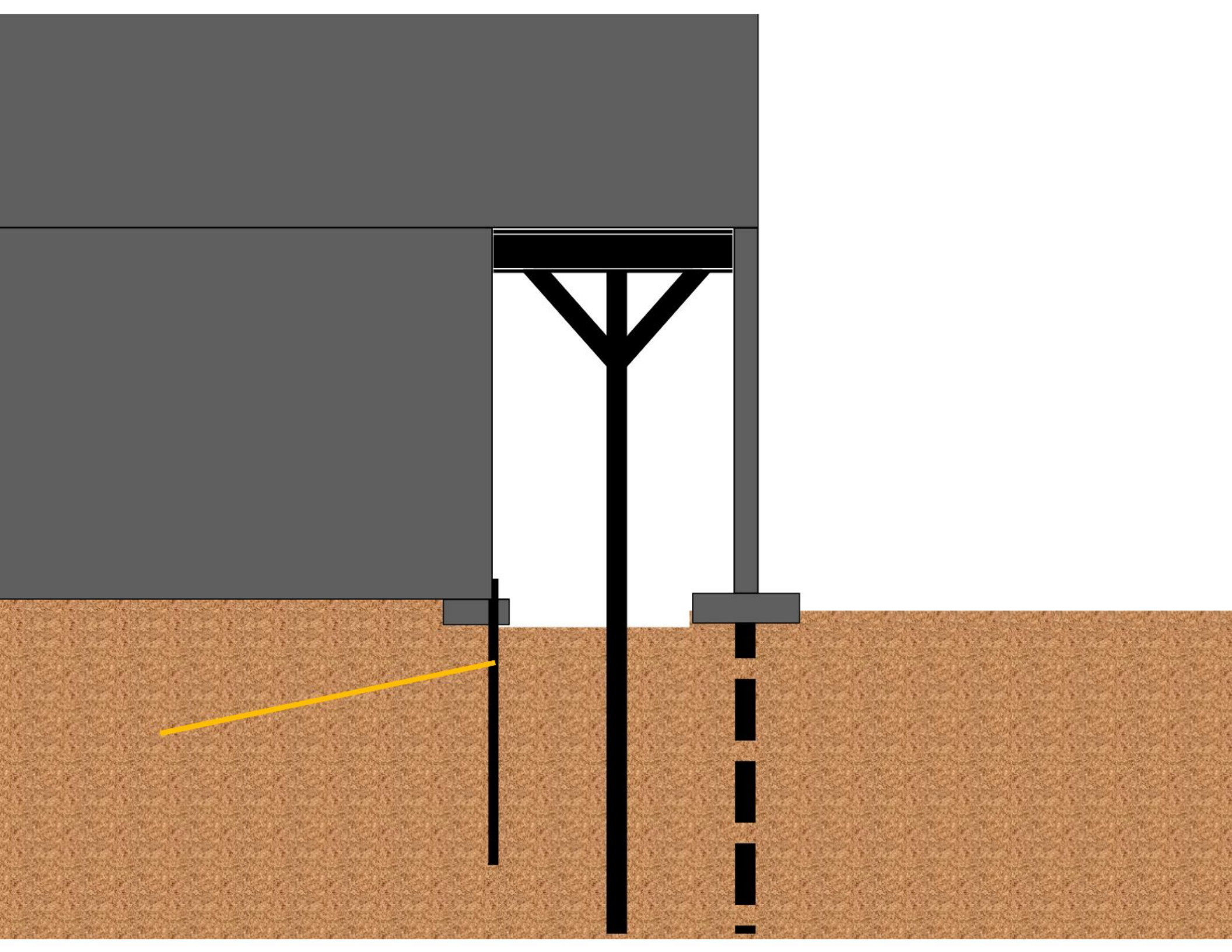



EMERGENCY
NO
PARKING

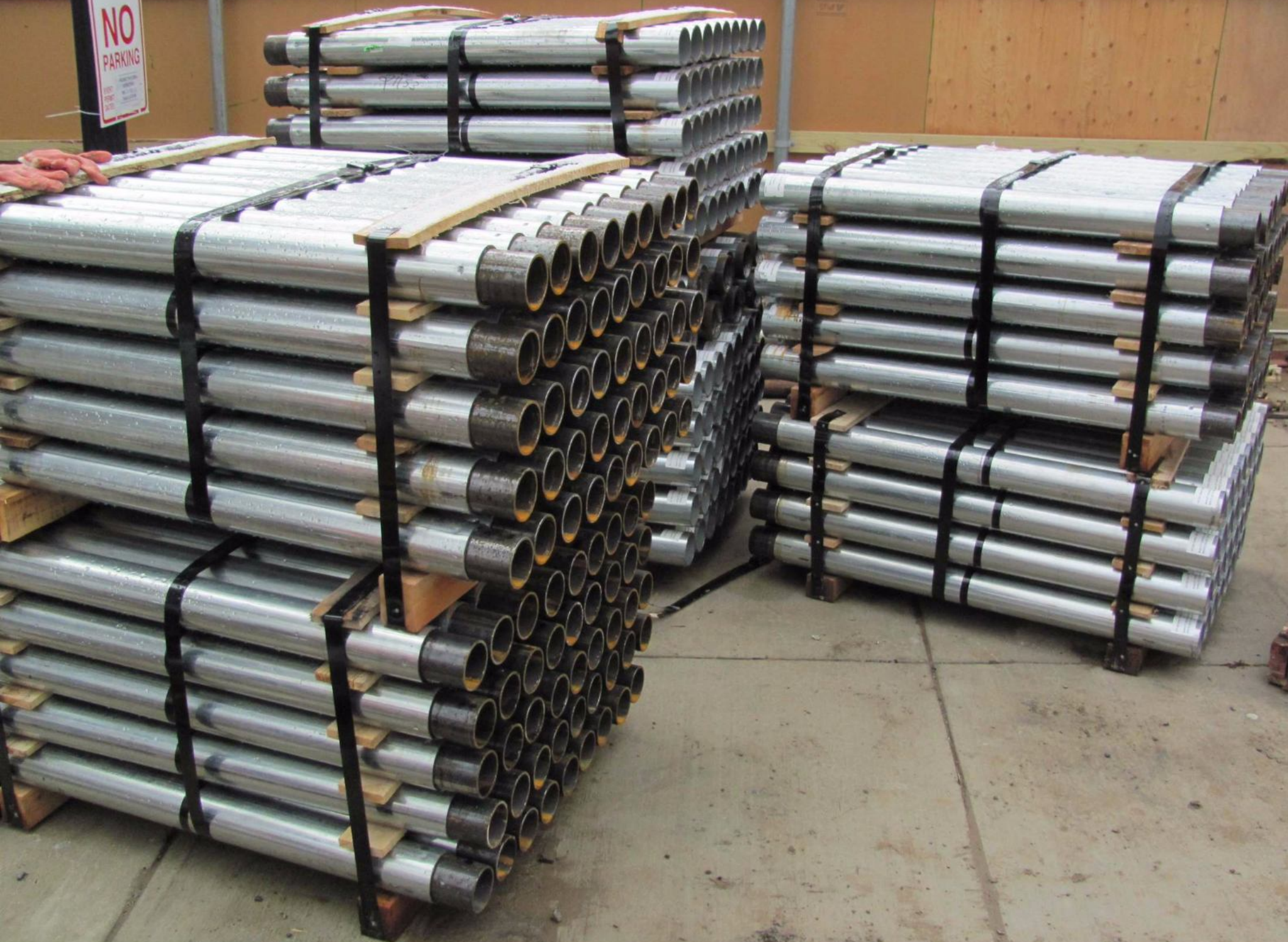















KLEMM
Fahrt technik

HAYWARD
BAKER
A KLEMM COMPANY
Geotechnical Construction
KELIER

3

2

1

2

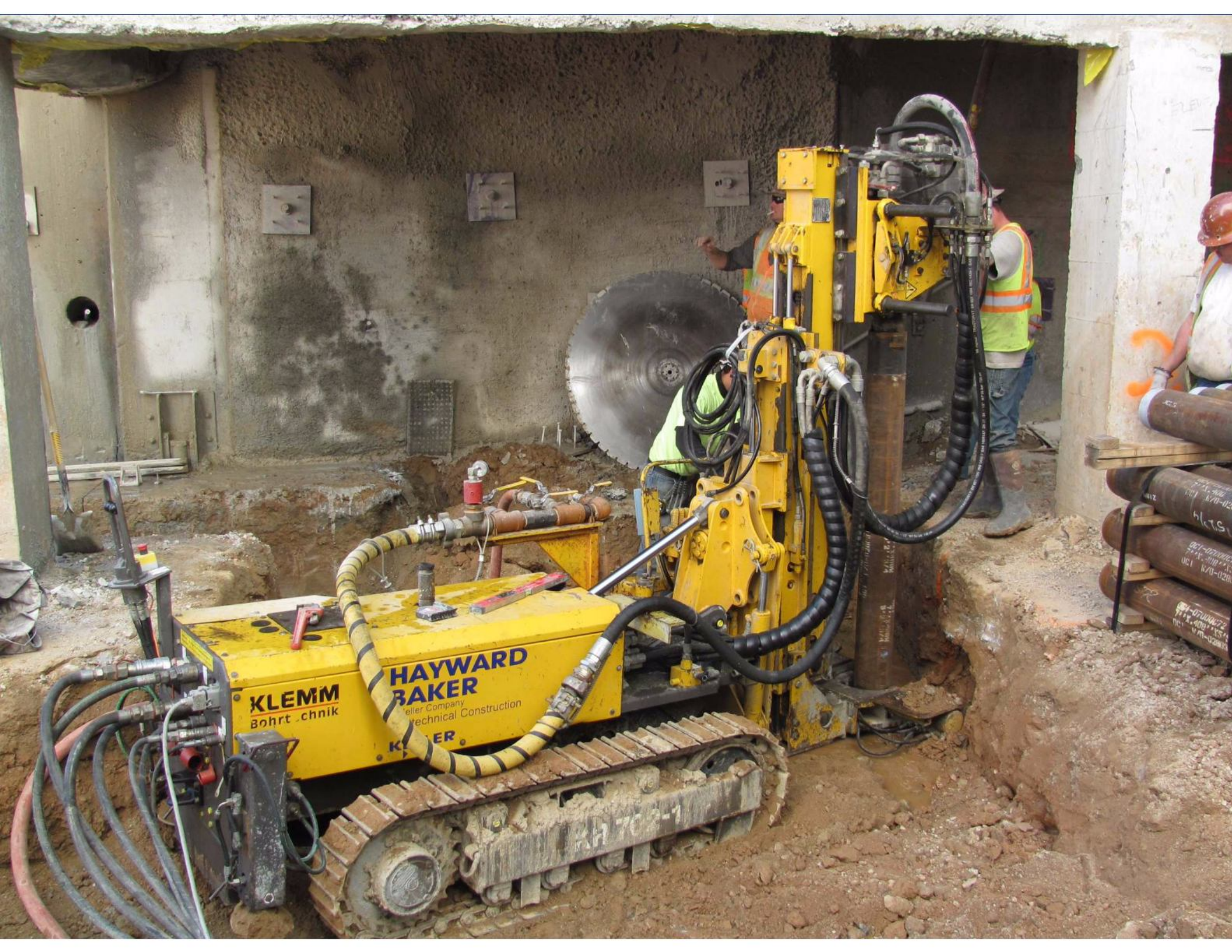

KLEMM
Bohrtchnik

**HAYWARD
BAKER**
eller Company
echnical Construction

KLEMM





**HAYWARD
BAKER**

8

REBAR FORMS



15/20 8-35961
10/21/09

CORE







HAYWARD
BAKER
CORP.











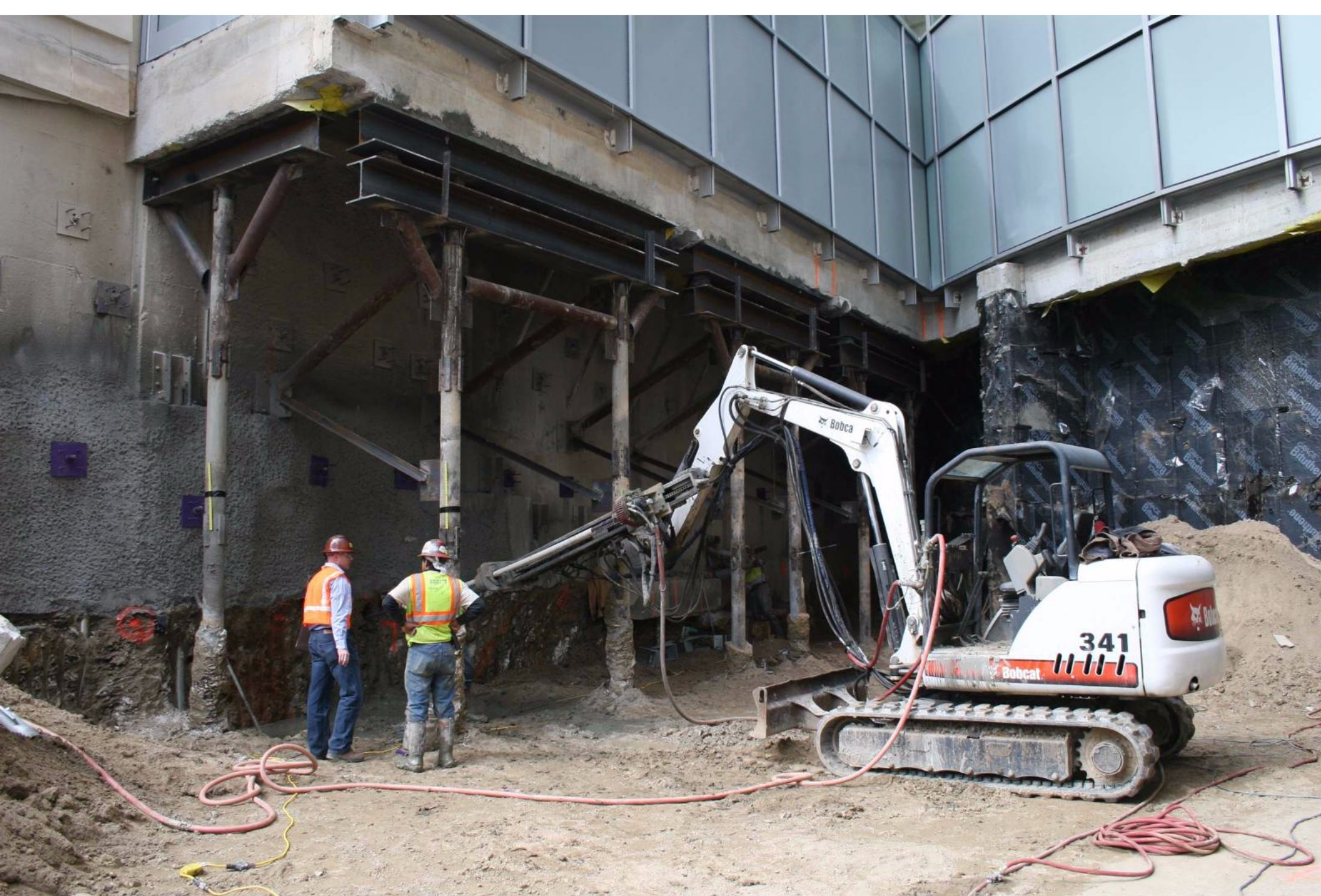

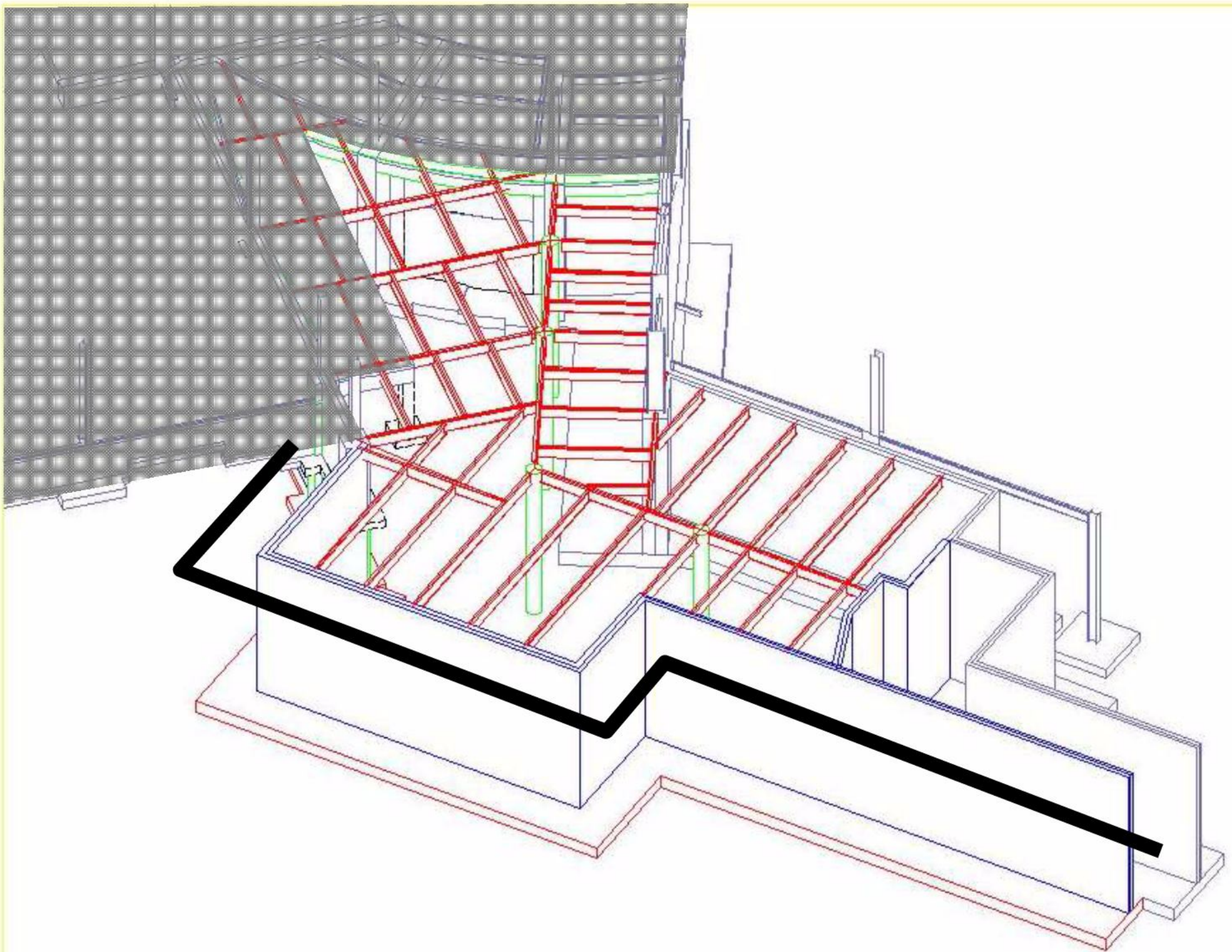

Installation of Soldier Piles





KOMATSU
PC228LC-6

SKYTRAK

8042

CERISEX



**Work Safe
Go Home Safe**

Thank You!

